

Digital electronic E-BM-AS drivers

DIN-rail panel format, for proportional valves without transducer

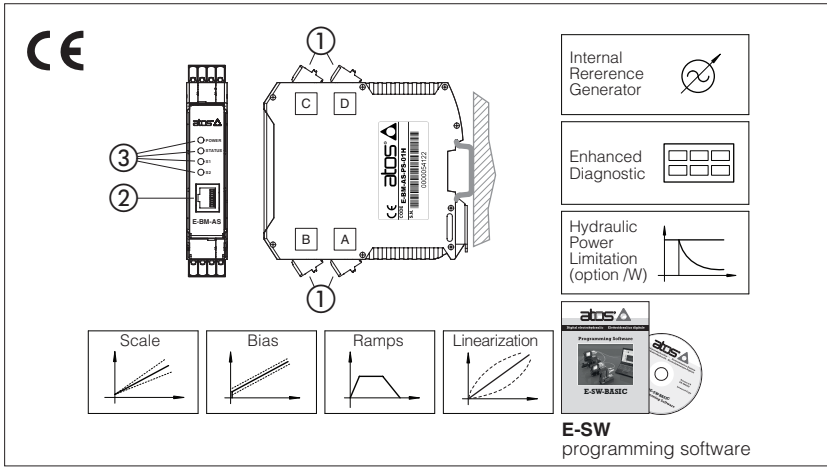

E-BM-AS

Digital drivers supply and control the current to the solenoid of Atos proportional valves without transducer, according to the electronic reference input signal. The solenoid proportionally transforms the current into a force, acting on the valve spool or poppet, against a reacting spring, thus providing the hydraulic regulation. E-BM-AS can drive up to two single or one double solenoid proportional valves.

Electrical Features:

- 4 fast plug-in connectors ①
- RJ45 connector ② for RS232 Serial communication to program the driver with the Atos PC software
- 4 leds for diagnostics ③ (see 8)
- ± 5 Vdc output supply for external reference potentiometers (/P option)
- Electrical protection against reverse polarity of power supply
- Operating temperature range: $-20^\circ \div +60^\circ$ (see 3)
- Plastic box with IP20 protection degree and standard DIN-rail mounting
- CE mark according to EMC directive

Software Features:

- Intuitive graphic interface
- Setting of valve's functional parameters: bias, scale, ramps, dither
- Linearization function for the hydraulic regulation
- 2 selectable modes for electronic reference signal: external analog input or internal generation
- /W option max power limitation function (see 6.7)
- Complete diagnostics of driver status

1 MODEL CODE

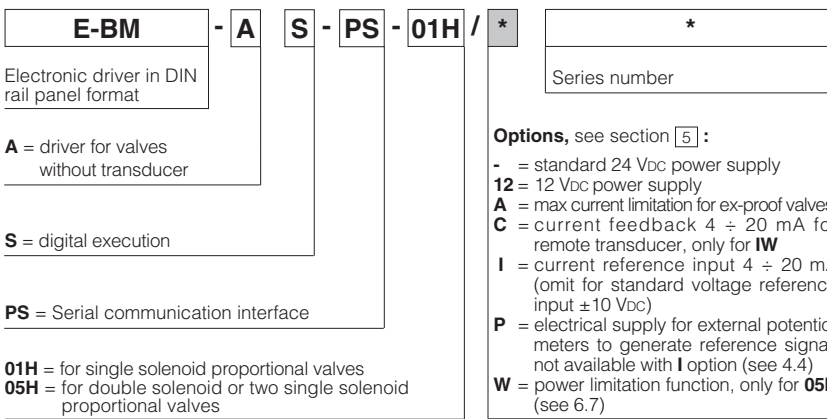

2 BLOCK DIAGRAM

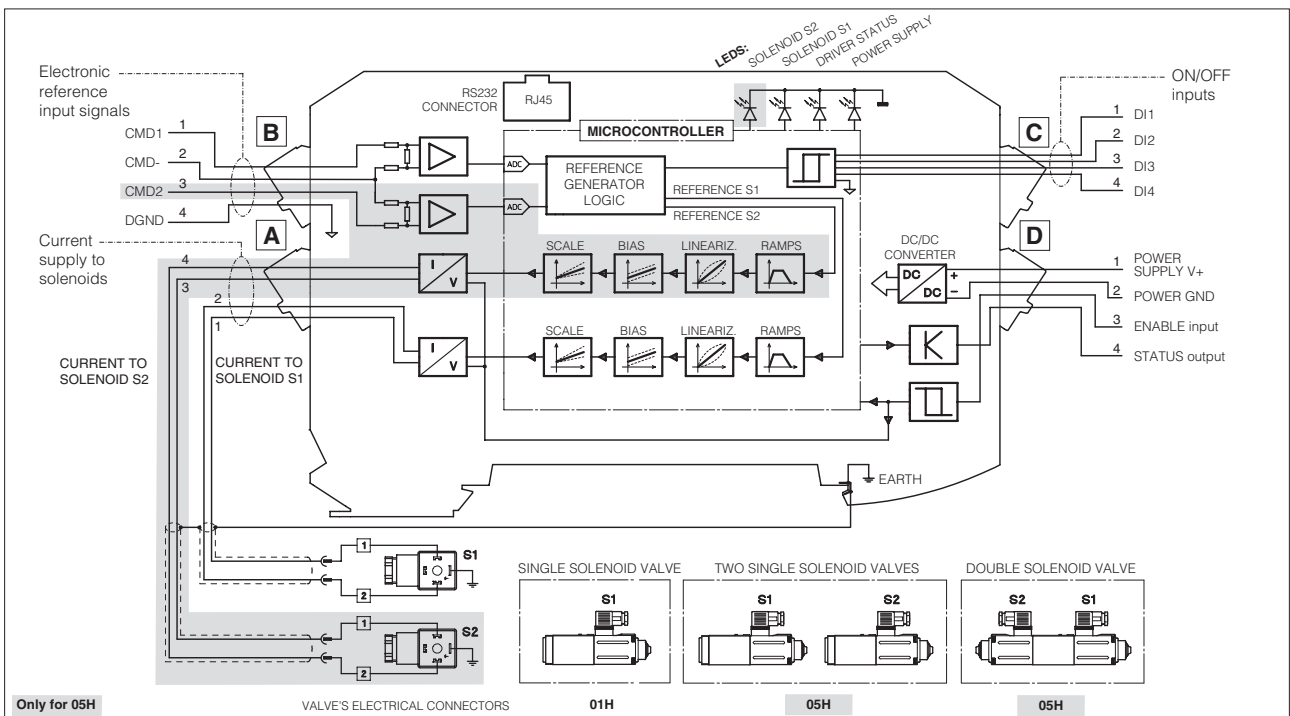

3 MAIN CHARACTERISTICS

Power supply (see 4.1)	Standard option /12 Nominal: +24 V _{DC} Rectified and filtered: V _{RMS} = 20 ÷ 32 V _{MAX} (ripple max 10 % V _{PP}) Nominal: +12 V _{DC} Rectified and filtered: V _{RMS} = 10 ÷ 14 V _{MAX} (ripple max 10 % V _{PP})
Max power consumption	50 W 01H single solenoid valve and 05H double solenoid valve 100 W 05H two single solenoid valves
Current supplied to solenoids	I _{MAX} = 2.7 A with +24 V _{DC} power supply to drive standard proportional valves (3,2 Ω solenoid) I _{MAX} = 3.3 A with +12 V _{DC} power supply to drive proportional valves with /6 option (2,1 Ω solenoid) I _{MAX} = 2.5 A with +24 V _{DC} power supply to drive ex-proof proportional valves (3,2 Ω solenoid) for /A option
Reference input signal (see 4.2)	Voltage: range ±10 V _{DC} Input impedance: Ri > 50 kΩ Current: range ±20 mA Input impedance: Ri = 500 Ω
Enable and ON/OFF inputs (see 4.5, 4.7)	Range : 0 ÷ 24 V _{DC} (OFF state: 0 ÷ 5 V _{DC} ; ON state: 9 ÷ 24 V _{DC}) Input impedance: Ri > 10 kΩ ;
Output supply (see 4.4)	±5 V _{DC} @ max 10 mA : output supply for external potentiometers (only for /P option)
Status output (see 4.6)	Output range : 0 ÷ 24 V _{DC} (ON state > [power supply - 2 V] ; OFF state < 1 V) @ max 1,4 A
Alarms	Solenoid not connected, short circuit and cable break with current reference signal
Format	Plastic box ; IP20 protection degree ; L 35 - H 7,5 mm rail mounting as per EN60715
Operating temperature	-20 ÷ +60 °C (-20 ÷ +40 °C for 05H version if drive two single solenoid proportional valves; storage -25 ÷ +85 °C)
Mass	130 g
Additional characteristics	Short circuit protection of current output to solenoids; protection against reverse polarity of power supply
Electromagnetic compatibility (EMC)	According to Directive 2014/30/UE - Immunity: EN 61000-6-2 (2005); Emission: EN 61000-6-4 (2001)
Communication interface	RS232 serial connection (not insulated), Atos protocol with ASCII coding (see section 5)
Recommended wiring cable	LiYCY shielded cables: 0,5 mm ² for length up to 40 m [1,5 mm ² for power supply and solenoids]

4 SIGNALS SPECIFICATIONS

4.1 Power supply

The power supply must be appropriately stabilized or rectified and filtered: apply at least a 10000 µF/40 V capacitance to single phase rectifiers or a 4700 µF/40 V capacitance to three phase rectifiers.

A safety fuse is required in series to each driver power supply: 2,5 A time lag fuse for 01H single solenoid valve and 05H double solenoid valve
5 A time lag fuse for 05H two single solenoid valves

Option /12

This driver execution is designed to receive a 12 V_{DC} power supply and it is commonly used in mobile application.

A safety fuse is required in series to each driver power supply: 4 A time lag fuse for 01H single solenoid valve and 05H double solenoid valve
6,3 A time lag fuse for 05H two single solenoid valves

4.2 Reference Input Signals (pin B1 and B3, both referred to pin B2)

The driver proportionally transforms the external reference input signal into the current supplied to the solenoid.

The driver is designed to receive one (01H) or two (05H) analog reference inputs (CMD1 on pin B1, CMD2 on pin B3); both signals are referred to a common electric ground (CMD- on pin B2). CMD1 has to be used in case of 05H version that drives one double solenoid valve.

The input range is software selectable among voltage (0 ÷ ±10 V_{DC}) or current (4 ÷ 20 mA with cable break detection or 0 ÷ ±20 mA).

Default settings: 0 ÷ 10 V_{DC} for two position valves; 0 ÷ ±10 V_{DC} for three position valves (see valve's tech. table).

Other ranges can be set by software. Internal reference generation is software selectable (see 6.6).

Note: software selection of analog input range (voltage or current) is applied to both signals CMD1 and CMD2.

4.3 Pressure Input Signal (pin B3 referred to pin B2) only for, /W option)

When hydraulic power limitation is active (see 6.7), input signal CMD2 must be connected to an external pressure transducer installed on the hydraulic system; maximum input range 0 ÷ 10 V_{DC}.

4.4 Output supply Signal for external reference potentiometers (/P option)

The reference analog signals can be generated by one (01H) or two (05H) external potentiometers directly connected to the driver, using the ±5 V_{DC} supply output available at pin C3 and C4. Reference input signal can be set up via software to ±5 V_{DC}, in order to match potentiometer output signal.

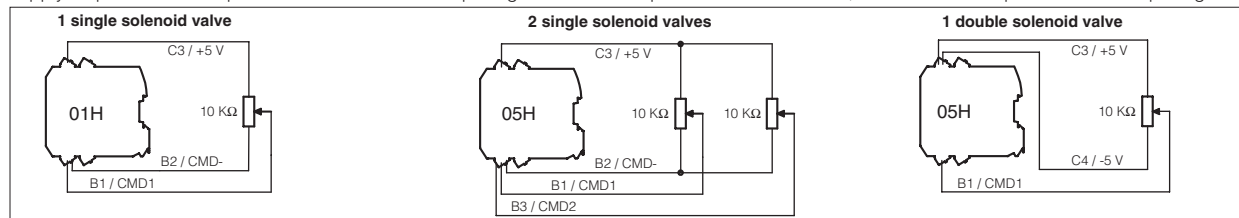

4.5 Enable Input Signal (pin D3 referred to pin D2)

Enable input signal allows to enable/disable the current supply to the solenoids, without removing the electrical power supply to the driver; it is used to maintain active the serial connection and the other driver functions when the valve must be disabled for safety reasons.

To enable the driver, supply a 24V_{DC} on pin D3 referred to pin D2.

4.6 Status Output Signal (pin D4 referred to pin D2)

Status output signal indicates fault conditions of the driver (short circuits, solenoids not connected, cable broken for 4 ÷ 20mA input) and is not affected by Enable input signal status: fault presence corresponds to 0 V_{DC}, normal working corresponds to 24 V_{DC}.

When hydraulic power limitation function is active (see 6.7), status output signal can be software configured to indicate power limitation status: not active (0 V_{DC}) or active (24 V_{DC}).

4.7 ON/OFF Input Signals (pin C1...C4 referred to DGND pin B4)

When the driver is configured in internal reference generation mode (see 6.6), the 4 ON/OFF input signals (DI) are used to select the active reference signal, among the available stored values. If the 4 ON/OFF input signals (DI) are not active, the driver can be commanded by external analog reference. The polarity of the digital inputs can be customized: active status = 24 V_{DC} is the default setting.

Note: with /P option two ON/OFF signals are available as digital inputs (DI).

4.8 Possible combined options: /12W, /12CIW, /12PW, /12CIW, /AW, /ACIW, /APW, /CIW, /PW only for 05H

/12I, /12P, /AI, /AP for 01H and 05H

5 PROGRAMMING TOOLS - see tech table GS500

Valve's functional parameters and configurations, can be easily set and optimized using Atos E-SW programming software connected via RS232 serial port to the digital driver. For fieldbus versions, the software permits valve's parameterization through serial port also if the driver is connected to the central machine unit via fieldbus.

The software is available in different versions according to the driver's options:

E-SW-BASIC support:	NP (USB)	PS (Serial)	IR (Infrared)
E-SW-FIELDBUS support:	BC (CANopen)	BP (PROFIBUS DP)	EH (EtherCAT)
	EW (POWERLINK)		
E-SW-/PQ support:	valves with SP, SF, SL alternated control (e.g. E-SW-BASIC/PQ)		

WARNING: drivers RS232 port is not isolated!

Free programming software, web download:

E-SW-BASIC web download = software can be downloaded upon web registration at www.download.atos.com ; service and DVD not included
Upon web registration user receive via email the Activation Code (software free license) and login data to access Atos Download Area

DVD programming software, to be ordered separately:

E-SW-BASIC DVD first supply = software has to be activated via web registration at www.download.atos.com ; 1 year service included
Upon web registration user receive via email the Activation Code (software license) and login data to access Atos Download Area

E-SW-BASIC-N DVD next supplies = only for supplies after the first; service not included, web registration not allowed
Software has to be activated with Activation Code received upon first supply web registration

Atos Download Area: direct access to latest releases of E-SW software, manuals, USB drivers and fieldbus configuration files at www.download.atos.com

USB Adapters, Cables and Terminators, can be ordered separately

Connection

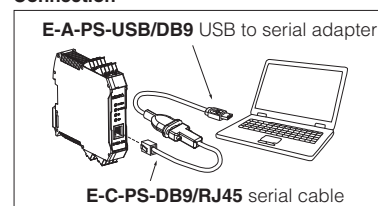

6 MAIN SOFTWARE PARAMETER SETTINGS

The following is a brief description of the main settings and features of digital drivers.

For a detailed descriptions of available settings, wirings and installation procedures, please refer to the user manual included in the E-SW programming software:

E-MAN-BM-AS - user manual for **E-BM-AS**

6.1 Scale

Scale function allows to set the maximum current supplied to the solenoid, corresponding to the max valve regulation, at maximum reference signal value.

This regulation allows to adapt the maximum current supplied from the driver to the specific nominal current of the proportional valves to which the driver is coupled; it is also useful to reduce the maximum valve regulation in front of maximum reference signal.

For double solenoid valves two different Scale regulations are available : ScaleA for positive reference signal and ScaleB for negative reference signal

6.1, 6.2 - Scale, Bias & Threshold

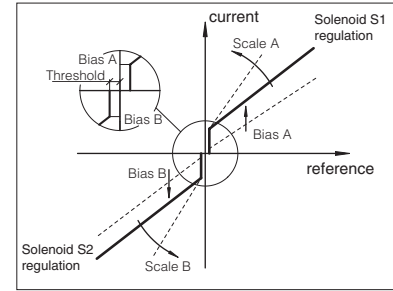

6.2 Bias and Threshold

Proportional valves may be provided with a dead band in the hydraulic regulation corresponding to their switch-off status.

This dead band discontinuity in the valve's regulation can be compensated by activating the Bias function, which adds a fixed preset Bias value to the reference signal (external input or internally generated).

The Bias function is activated when the reference signal overcome the Threshold value, preset into the driver.

The Bias setting allows to calibrate the Bias current supplied to the solenoid of the specific proportional valve to which the driver is coupled.

The Threshold setting is useful to avoid undesired valve regulation at zero reference signal when electric noise is present on the analog input signal: smaller threshold reduces the reference signal dead band, greater values are less affected by electric noise presence.

If internal reference generation is active (see 6.6), threshold should be set to 0.

For double solenoid valves two different Bias regulations are available: positive reference signal activates BiasA for solenoid S1 and negative reference signal activates BiasB for solenoid S2

6.3 - Ramps

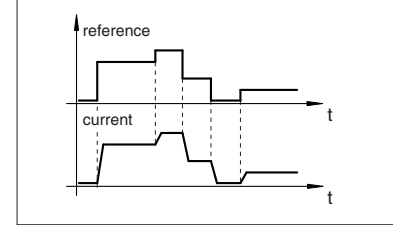

6.3 Ramps

The ramp generator allows to convert sudden change of electronic reference signal into smooth time-dependent increasing/decreasing of the current supplied to the solenoid.

Different ramp mode can be set:

- single ramp for any reference variation
- two ramps for increasing and for decreasing reference variations
- four ramps for positive/negative signal values and increasing/decreasing reference variations

Ramp generator is useful for application where smooth hydraulic actuation is necessary to avoid machine vibration and shocks.

If the proportional valve is driven by a closed loop controller, the ramps can lead to unstable behaviour, for these applications ramp function can be software disabled (default setting)

6.4 - Dither

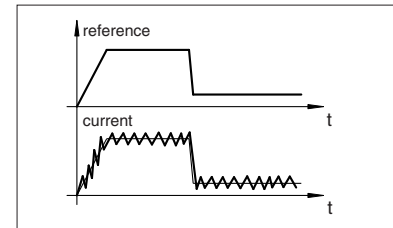

6.4 Dither

The dither is an high frequency modulation of the current supplied to the solenoid, to reduce the hysteresis of the valve's regulation: a small vibration in the valve's regulating parts considerably reduces static friction effects.

Dither frequency can be set in a range from 80 to 500 Hz (default value is 200Hz).

Lower dither setting reduces the hysteresis but also reduces the regulation stability. In some application this can lead to vibration and noise: right setting usually depends on system setup.

Default dither is a valid setting for a wide range of hydraulic applications

6.5 - Linearization

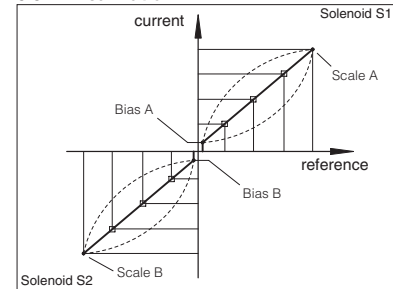

6.5 Linearization

Linearization function allows to set the relation between the reference input signal and the current supplied to the solenoid.

Linearization is useful for applications where it is required to linearize the valve's regulation in a defined working condition (e.g. maximum pressure control at defined working flow)

6.6 Internal Reference Generation

Internal generation of reference values is software selectable.

In this mode the 4 digital inputs of the driver (DI1..DI4) allow to activate the desired internal reference signal, among the different driver's stored values: external control unit can thus manage complex machine profile by simple switching the reference signal, by 4 digital inputs (see 4.7).

The digital inputs are software configurable into 2 different reference selection mode:

- **Standard mode**
each digital input corresponds to a different value; up to 4 different internal values are available (2+2 with E-BM-AS-PS-05H driving two single solenoid valves)
- **Binary mode**
each digital input combination corresponds to a different value; up to 15 different internal values are available (3+3 with E-BM-AS-PS-05H when driving two single solenoid valves)

A dedicated ramp time value can be set by software for each available stored reference value.

Note: with all input signals (DI) set to zero, the driver can be commanded by external analog reference also if internal reference generation is selected (for more information please refer to the programming manual E-MAN-BM-AS).

6.6 - Internal Reference Generation

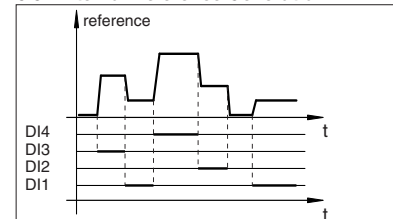

Single internal generator selection (standard mode)				
DI1	DI2	DI3	DI4	Reference
OFF	OFF	OFF	OFF	External
ON	OFF	OFF	OFF	Generation 1
(*)	ON	OFF	OFF	Generation 2
(*)	(*)	ON	OFF	Generation 3
(*)	(*)	(*)	ON	Generation 4

Double internal generator selection (standard mode)					
DI1	DI2	S1	DI3	DI4	S2
OFF	OFF	External	OFF	OFF	External
ON	OFF	Generation 1	ON	OFF	Generation 1
(*)	ON	Generation 2	(*)	ON	Generation 2

(*) Note: Don't care

6.7 Hydraulic Power Limitation (W option, only for drivers E-BM-AS-PS-05H)

E-BM-AS drivers with W option electronically perform hydraulic power limitation on:

- direct and pilot operated flow control valves
- direct and pilot operated directional control valves + mechanical pressure compensator
- variable displacement pumps with proportional flow regulator (e.g. PVPC*-LQZ, tech.tab. A170)

The driver receives the flow reference signal by the analog external input CMD1 (see 4.2) or by the internal generator (see 6.6), and a pressure transducer, installed in the hydraulic system, has to be connected to the driver's analog input CMD2.

When the actual requested hydraulic power $p \times Q$ (CMD2x CMD1) reaches the max power limit ($p1 \times Q1$), internally set by software, the driver automatically reduces the flow regulation of the valve. The higher is the pressure feedback the lower is the valve's regulated flow:

$$\text{Flow regulation} = \text{Min} \left(\frac{\text{PowerLimit [sw setting]}}{\text{Transducer Pressure [CMD2]}} ; \text{Flow Reference [CMD1]} \right)$$

6.7 - Hydraulic Power Limitation

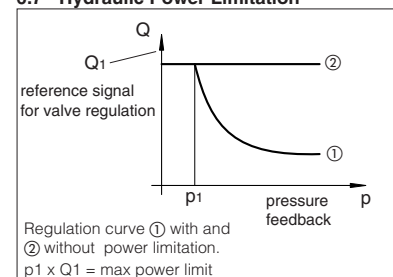

7 CONNECTIONS

The 4 fast plug-in connectors (A,B,C,D), included in the supply, provide simple wirings, easy driver's replacement and the possibility to test the signals directly on the connectors.

CONNECTOR	PIN	SIGNAL	TECHNICAL SPECIFICATIONS		NOTES	
A	A1	SOL S1	Current to solenoid S1		Output - power PWM	
	A2					
	A3	SOL S2	Current to solenoid S2 (only for 05H version)			
	A4					
B	B1	CMD1	Reference analog input: ± 10 V _{DC} / ± 20 mA maximum range software selectable (see 4.2)	/P option (see 4.4)	Input - analog signal	
	B2	CMD-	Standard			
			Zero signal, ground for reference signals	Reference for ± 5 V _{DC} output (AGND)		
	B3	CMD2 (1)	Reference analog input: ± 10 V _{DC} / ± 20 mA maximum range software selectable (see 4.2)			
B4	DGND	Optical insulated ground for on/off inputs (DI1 ÷ DI4)				
C			Standard	/P option (see 4.4)	Standard	Option /P
	C1	DI1	Optical insulated on/off input 0 ÷ 24 V _{DC} referred to pin B4 (DGND) (see 4.7)	as standard	Input - on/off signal	
	C2	DI2		as standard		
	C3	DI3		+5 V _{DC} @ 10 mA output supply to pin B2 (AGND)	Input - on/off	Output - reference analog
	C4	DI4		-5 V _{DC} @ 10 mA output supply to pin B2 (AGND)		
D	D1	V+	Power supply 24 V _{DC} (see 4.1)		Input - power supply	
	D2	V0	Power supply 0 V _{DC}			
	D3	ENABLE	Enable (24 V _{DC}) or disable (0 V _{DC}) the driver (see 4.5)			
	D4	STATUS	Fault (default) or software selected output (see 4.6)			

Note (1): only for 05H version, when used to drive two single solenoid valves or transducer input for /P option.

WARNING: if CMD2 is not used must be connect to CMD- (ground)

8 FRONT PANNEL CONNECTOR AND LEDS

RJ45 CONNECTOR			DIAGNOSTIC LEDS	
PIN	SIGNAL	DESCRIPTION	POWER (GREEN LED)	
1	/	Not connected	Light signal displayed	Power supply status
2	/	Not connected	Light Off	Power OFF
3	/	Not connected	Light On	Power ON
4	GND	Signal zero data line	STATUS (GREEN LED)	
5	RX	Driver receiving data line	Light signal displayed	Driver status
6	TX	Driver transmitting data line	Light Off or Light On	Fault conditions
7	/	Not connected	Slow blinking	Driver disabled
8	/	Not connected	Fast blinking	Driver enabled
			S1 & S2 (YELLOW LEDS)	
			Light signal displayed	Coil status
			Light Off	PWM command OFF
			Light On	PWM command ON
			Slow blinking	Coil not connected
			Fast blinking	Short circuit on the solenoid

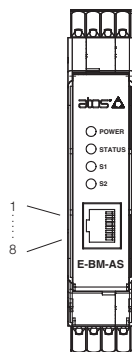

RJ45 connector (IEC 60603 standard) for RS232 serial communication

9 OVERALL DIMENSIONS [mm] AND INSTALLATION

